

---

# Chapter 2

# Soils

---

---

<b>Contents:</b>	<b>652.0200</b>	<b>Introduction</b>	<b>2-1</b>
	<b>652.0201</b>	<b>General</b>	<b>2-1</b>
		(a) Soil survey .....	2-1
		(b) Soil survey data base .....	2-2
		(c) Soil limitations for irrigation .....	2-2
	<b>652.0202</b>	<b>Physical soil characteristics</b>	<b>2-4</b>
		(a) Soil properties and qualities .....	2-4
		(b) Soil-water holding capacity .....	2-4
		(c) Soil intake characteristics .....	2-17
		(d) Organic matter .....	2-28
		(e) Soil depth .....	2-28
		(f) Slope .....	2-29
		(g) Water tables .....	2-29
		(h) Soil erodibility .....	2-29
		(i) Chemical properties .....	2-31
		(j) Saline and sodic soil effects .....	2-31
		(k) Soil reaction/acidity .....	2-32
	<b>652.0203</b>	<b>Explanation of tables and data bases</b>	<b>2-34</b>
	<b>652.0204</b>	<b>State supplement</b>	<b>2-34</b>
		(a) Soil surveys .....	2-34
		(b) Soil properties .....	2-34

---

<b>Tables</b>	<b>Table 2-1</b>	Available water capacity (AWC) by texture	2-5
	<b>Table 2-2</b>	Correction of available water capacity for rock fragment content	2-6
	<b>Table 2-3</b>	Available water capacity adjustment factors	2-7
	<b>Table 2-4</b>	Available water capacity adjustments because of salinity	2-10

<b>Table 2-5</b>	General terms, symbols, and size of soil separates for basic soil texture classes	2-11
<b>Table 2-6</b>	Soil intake ranges by surface texture	2-17
<b>Table 2-7</b>	Maximum net application amounts with zero potential runoff for center pivot systems	2-21
<b>Table 2-8</b>	Maximum sprinkler application rate—periodic move and fixed set sprinkler (for alfalfa-grass, grass, or clean tilled with residue > 4,000 lb/ac)	2-22
<b>Table 2-9</b>	Soil intake family adjustment factors	2-23
<b>Table 2-10a</b>	Amount of surface storage needed for no runoff—Silty clay	2-25
<b>Table 2-10b</b>	Amount of surface storage needed for no runoff—Silty clay loam	2-25
<b>Table 2-10c</b>	Amount of surface storage needed for no runoff—Silt loam	2-26
<b>Table 2-10d</b>	Amount of surface storage needed for no runoff—Loam	2-26
<b>Table 2-10e</b>	Amount of surface storage needed for no runoff—Fine sandy loam	2-26
<b>Table 2-10f</b>	Amount of surface storage needed for no runoff—Loamy fine sand	2-26
<b>Table 2-10g</b>	Amount of surface storage needed for no runoff—Fine sand	2-27
<b>Table 2-11</b>	Estimated effective basin surface storage	2-28
<b>Table 2-12</b>	Surface storage available for rough and cloddy bare ground	2-28
<b>Table 2-13</b>	Surface storage available with residue	2-28
<b>Table 2-14</b>	Soil erodibility hazard (S K values) for surface irrigation	2-30
<b>Table 2-15</b>	Soil properties and design values for irrigation	2-34

<b>Figures</b>	<b>Figure 2-1</b>	Typical water release curves for sand, loam, and clay	2-9
	<b>Figure 2-2</b>	Examples of soil structure	2-13
	<b>Figure 2-3</b>	Intake families for border and basin irrigation design	2-18
	<b>Figure 2-4</b>	Intake families for furrow irrigation design	2-19
	<b>Figure 2-5a</b>	Nomenclature—dike spacing and height; furrow width and ridge height and spacing	2-27
	<b>Figure 2-5b</b>	Dike spacing, height, and surface storage capacity	2-27
	<b>Figure 2-6</b>	Water table contribution to irrigation requirement, as a function of soil type (texture) and water table depth	2-29
	<b>Figure 2-7</b>	Example soil-water retention curves for clay loam soil at varying levels of soil salinity— $EC_e$	2-31
	<b>Figure 2-8</b>	Threshold values of sodium adsorption ratio of topsoil and electrical conductivity of infiltrating water associated with the likelihood of substantial losses in permeability	2-32
	<b>Figure 2-9</b>	Effect of pH on nutrient availability in soils	2-33
<b>Exhibits</b>	<b>Exhibit 2-1</b>	Soil properties, limits, and restrictive features for irrigation	2-3
	<b>Exhibit 2-2</b>	Process to determine total volume of water held in a soil	2-16

---

### 652.0200 Introduction

Plant response to irrigation is influenced by the physical condition, fertility, and biological status of the soil. Soil condition, texture, structure, depth, organic matter, bulk density, salinity, sodicity, acidity, drainage, topography, fertility, and chemical characteristics all determine the extent to which a plant root system grows into and uses available moisture and nutrients in the soil. Many of these factors directly influence the soil's ability to store, infiltrate, or upflux water delivered by precipitation or irrigation (including water table control). The irrigation system(s) used should match all or most of these conditions.

Many conditions influence the value of these factors. The estimated values for available water capacity and intake are shown as rather broad ranges. Working with ranges is a different concept than used in previous irrigation guides. In the field, ranges are normal because of many factors. The values in local soils data bases need to be refined to fit closer to actual field conditions. The actual value may vary from site to site on the same soil, season to season, and even throughout the season. It varies throughout the season depending on the type of farm and tillage equipment, number of tillage operations, residue management, type of crop, water quality, and even water temperature.

Soils to be irrigated must have adequate surface and subsurface drainage. Internal drainage within the crop root zone can be either natural or from an installed subsurface drainage system.

This guide describes ways to interpret site conditions for planning and design decisions. Where necessary, actual field tests should be run to determine specific planning and design values for a specific field. Evaluation results can also be used to fine tune individual irrigation system operations and management. When a particular soil is encountered frequently in an area, efforts should be made to gather field data to verify the site conditions or to use in refining values in the guide. These field derived values should be added as support for data presented in the guide.

---

### 652.0201 General

Soil consists of mineral and organic materials, covering much of the Earth's surface. It contains living matter, air, and water, and can support vegetation. People have altered the soil in many places. Soil is one of the resources of major concern to USDA and the Natural Resources Conservation Service. The soil functions as a storehouse for plant nutrients, as habitat for soil organisms and plant roots, and as a reservoir for water to meet evapotranspiration (ET) demands of plants. It contains and supplies water, oxygen, nutrients, and mechanical support for plant growth.

Soil is a basic irrigation resource that determines how irrigation water should be managed. The amount of water the soil can hold for plant use is determined by its physical and chemical properties. This amount determines the length of time that a plant can be sustained adequately between irrigation or rainfall events, the frequency of irrigation, and the amount and rate to be applied. Along with plant ET, it also determines the irrigation system capacity system needed for desired crop yield and product quality.

#### (a) Soil survey

NRCS is responsible for leadership of the National Cooperative Soil Survey. Partners include other Federal, State, and local agencies and institutions. Soil survey data and interpretations have information that can be used for planning, design, and management decisions for irrigation.

Soil map units represent an area on the landscape and consist of one or more soils for which the unit is named. Single fields are rarely a single map unit or a single soil. Many soil map units include contrasting soil inclusions considered too minor to be a separate map unit. Because of variations in soil properties that exist in map units, additional onsite soils investigations are often needed.

Soil properties within a profile can be modified by land grading, deep plowing, subsoiling, or other deep tillage practices. Shallow tillage practices can affect water infiltration and soil permeability rates. These property changes may not be reflected in the map unit description. Personnel doing irrigation planning are expected to obtain accurate onsite soil information to make recommendations. Adjacent farms may need different recommendations for the same soil series because different equipment, tillage practices, and number of tillage operations are used.

### (b) Soil survey data base

Soil survey data are available from the local National Soil Information System (NASIS) Map Unit Interpretation Record (MUIR) soil data base on the Field Office Computing System (FOCS). Irrigation related software applications access this data base through a soil characteristics editor to create point data located within a field or operating unit. Where maximum and minimum ranges of soil attribute data are contained in the data base (for example, percent rock or available water capacity), the editor can be used to select or input the appropriate value. If a soil profile has been examined in the field, then data for the profile are entered instead of using the data base. Soil data points created in this way can be used to create summary soil reports, or the data can be used directly either manually or in irrigation related software applications.

### (c) Soil limitations for irrigation

Exhibit 2-1 displays soil limitations when determining the potential irrigability of a soil. It displays specific limits and restrictive features for various soil properties; however, it does not necessarily mean the soil should not be irrigated. A restriction indicates there are limitations for selection of crops or irrigation method and will require a high level of management. Some restrictions may require such an excessive high level of management that it may not be feasible to irrigate that soil. Likewise, a deep well drained loamy soil with minor restrictions can become nonirrigable due to poor water management decisions and cultural practices.

**Exhibit 2-1** Soil properties, limits, and restrictive features for irrigation<sup>1/</sup>

Property	Limits	Restrictive features
USDA surface texture	COS, S, FS, VFS, LCOS, LS, LFS, LVFS	High intake for surface irrigation systems.
USDA surface texture	SIC, C, CS	Low intake for level basin and center pivot irrigation systems.
Slope surface	>3%	Water runoff.
Weight percent of stone particles >3" (weighted avg. to 40" depth)	>25%	Large stones, reduced plant root zone AWC.
Ponding	+	Soil air is removed.
Depth to high water table during growing season	<3 ft	Restricted plant root zone.
Available water capacity (weighted avg. to 40" depth)	<.05 in/in	Limited soil water storage for plant growth.
Wind erodibility group	1, 2, 3	Soil blowing damages young plants, reduces crop yield and quality.
Permeability, 0-60"	<.02 in/hr	Water percolates slowly.
Depth to bedrock	<40 in	Restricted plant root zone.
Depth to cemented pan	<40 in	Restricted plant root zone.
Erosion factor of surface, k	>.35	Erodes easily.
Flooding	Occasionally, frequently	Soil air is removed, plants damaged.
Salinity, 0-40"	>1 dS/m	Excess calcium and magnesium ions.
Sodicity, 0-40" SAR	>13	Excess sodium ions.
Calcium carbonate equivalent (% in thickest layer, 10-60" depth)	>40	Excess lime.
Sulfidic materials, Great Group	Sulfaquents, sulfihemists	Excess sulfur.
Soil reaction, pH, at any depth 0-60"	<5.0 or >8.0	Too acid or too alkaline.

1/ Part 620, NRCS, National Soil Survey Handbook, 1993.

## 652.0202 Physical soil characteristics

### (a) Soil properties and qualities

Soil properties and qualities are important in design, operation, and management of irrigation systems. These properties include water holding capacity, soil intake characteristics, permeability, soil condition, organic matter, slope, water table depth, soil erodibility, chemical properties, salinity, sodicity, and soil reaction (pH).

### (b) Soil-water holding capacity

The potential for a soil to hold water is important in designing and managing an irrigation system. Total water held by a soil is called water holding capacity. However, not all soil-water is available for extraction by plant roots. The volume of water available to plants that a soil can store is referred to as available water capacity.

#### (1) Available Water Capacity (AWC)

This is the traditional term used to express the amount of water held in the soil available for use by most plants. It is dependent on crop rooting depth and several soil characteristics. Units of measure are expressed in various terms:

- Volume unit as inches of water per inch or per foot of soil depth
- Gravimetric percent by weight
- Percent on a volume basis

In fine textured soils and soils affected by salinity, sodicity, or other chemicals, a considerable volume of soil water may not be available for plant use.

#### (2) Soil-water potential

Soil-water potential is a more correct way to define water available to plants. It is the amount of work required per unit quantity of water to transport water in soil. In the soil, water moves continuously in the direction of decreasing potential energy or from higher water content to lower water content. The concept of soil-water potential replaces arbitrary gravitational, capillary, and hygroscopic terms. Total water potential

consists of several components. It is the sum of matric, solute, gravitational, and pressure potential. Refer to the National Engineering Handbook (NEH), Section 15, Chapter 1, Soil-Plant-Water Relationships for a detailed explanation of this concept.

The soil-water potential concept will become more integrated into field procedures as new procedures evolve. For practical reasons, the terms and concepts of field capacity and permanent wilting point are maintained. Units of bars and atmospheres are generally used to express suction, tension, stress, or potential of soil water.

**(i) Field capacity**—This is the amount of water a well-drained soil holds after *free* water has drained because of gravity. For coarse textured soil, drainage occurs soon after irrigation because of relatively large pores and low soil particle surface tension. In fine textured soil, drainage takes much longer because of smaller pores and their horizontal shape. Major soil properties that affect field capacity are texture, structure, bulk density, and strata within the profile that restrict water movement. Generally, fine textured soil holds more water than coarse textured soil. Some soils, such as some volcanic and organic soils, are unique in that they can retain significant volumes of water at tensions less than one-tenth bar, thereby giving them a larger available water capacity.

An approximation of field capacity soil-water content level can be identified in the laboratory. It is the water retained in a soil when subjected to a tension of one-tenth atmosphere (bar) for sandy soils and one-third atmosphere for other finer textured soils.

Field capacity water content level can be estimated in the field immediately following a rain or irrigation, after free water has drained through the soil profile. Some judgment is necessary to determine when free water has drained and field capacity has been reached. Free water in coarse textured soils (sandy) can drain in a few hours. Medium textured (loamy) soils take approximately 24 hours, while fine textured (clayey) soils may take several days.

**(ii) Permanent wilting point**—This is the soil-water content at which most plants cannot obtain sufficient water to prevent permanent tissue damage. The lower limit to the available water capacity has been reached for a given plant when it has so ex-

hausted the soil moisture around its roots as to have irrecoverable tissue damage, thus yield and biomass are severely and permanently affected. The water content in the soil is then said to be the permanent wilting percentage for the plant concerned.

Experimental evidence shows that this water content point does not correspond to a unique tension of 15 atmospheres for all plants and soils. The quantity of water a plant can extract at tensions greater than this figure appears to vary considerably with plant species, root distribution, and soil characteristics. Some plants show temporary plant moisture stress during hot daytime periods and yet have adequate soil moisture. In the laboratory, permanent wilting point is determined at 15 atmospheres tension. Unless plant specific data are known, any water remaining in a soil at greater than 15 atmosphere tension is considered unavailable for plant use.

Major soil characteristics affecting the available water capacity are texture, structure, bulk density, salinity, sodicity, mineralogy, soil chemistry, and organic matter content. Of these, texture is the predominant factor in mineral soils. Because of the particle configuration in certain volcanic ash soils, these soils can contain very high water content at field capacity levels. This provides a high available water capacity value. Table 2-1 displays average available water capacity based on soil texture. Table 2-2 provides adjustments to the available water capacity based on percent rock fragments. Generally, rock fragments reduce available water capacity.

The available water capacity value shown on the Soil Interpretation Record (SOI-5) accounts for the estimated volume of coarse fragments for the specific soil series. However, any additional coarse fragments found upon field checking must be accounted for. Coarse fragments of volcanic material, such as pumice and cinders, can contain water within the fragments themselves, but this water may not be available for plant use because of the restricted root penetration and limited capillary water movement. A process to adjust the available water capacity based on additional field information is displayed in table 2-3.

**Table 2-1** Available water capacity (AWC) by texture

Texture symbol	Texture	AWC range (in/in)	AWC range (in/ft)	Est. typical AWC (in/ft)
COS	Coarse sand	.01 – .03	.1 – .4	.25
S	Sand	.01 – .03	.1 – .4	.25
FS	Fine Sand	.05 – .07	.6 – .8	.75
VFS	Very fine sand	.05 – .07	.6 – .8	.75
LCOS	Loamy coarse sand	.06 – .08	.7 – 1.0	.85
LS	Loamy sand	.06 – .08	.7 – 1.0	.85
LFS	Loamy fine sand	.09 – .11	1.1 – 1.3	1.25
LVFS	Loamy very fine sand	.10 – .12	1.0 – 1.4	1.25
COSL	Coarse sandy loam	.10 – .12	1.2 – 1.4	1.3
SL	Sandy loam	.11 – .13	1.3 – 1.6	1.45
FSL	Fine Sandy Loam	.13 – .15	1.6 – 1.8	1.7
VFSL	Very fine sandy loam	.15 – .17	1.8 – 2.0	1.9
L	Loam	.16 – .18	1.9 – 2.2	2.0
SIL	Silt loam	.19 – .21	2.3 – 2.5	2.4
SI	Silt	.16 – .18	1.9 – 2.2	2.0
SCL	Sandy clay loam	.14 – .16	1.7 – 1.9	1.8
CL	Clay loam	.19 – .21	2.3 – 2.5	2.4
SICL	Silty clay loam	.19 – .21	2.3 – 2.5	2.4
SC	Sandy clay	.15 – .17	1.8 – 2.0	1.9
SIC	Silty clay	.15 – .17	1.8 – 2.0	1.9
C	Clay	.14 – .16	1.7 – 1.9	1.8

**Table 2-2** Correction of available water capacity for rock fragment content <sup>1/</sup>

Soil	----- % coarse fragments (by volume) -----								
	0	10	20	30	40	50	60	65	70
	----- % passing #10 sieve (by weight) -----								
	100	85	70	55	45	35	25	20	20
----- Available water capacity (in/in) -----									
Clay	.14-.16	.12-.14	.11-.12	.09-.10	.08-.09	.06-.07	.05-.06	.04-.05	.03-.04
Silty clay	.15-.17	.13-.15	.11-.13	.10-.11	.08-.10	.07-.08	.06-.07	.05-.06	.04-.05
Sandy clay	.15-.17	.13-.15	.12-.14	.10-.11	.08-.09	.07-.08	.06-.07	.04-.05	.04
Silty clay loam	.19-.21	.17-.19	.15-.17	.13-.15	.11-.13	.09-.11	.08-.09	.06-.07	.06
Clay loam	.19-.21	.17-.19	.15-.17	.13-.15	.11-.13	.09-.11	.08-.09	.06-.07	.06
Sandy clay loam	.14-.16	.12-.14	.11-.13	.10-.11	.08-.10	.07-.08	.06-.07	.05-.06	.04-.05
Silt loam	.19-.21	.17-.19	.15-.17	.13-.15	.11-.13	.09-.11	.08-.09	.06-.07	.06
Loam	.16-.18	.14-.16	.13-.14	.11-.13	.10-.11	.08-.09	.07-.08	.05-.06	.05
Very fine sandy loam	.15-.17	.13-.15	.12-.14	.10-.12	.09-.10	.07-.09	.07-.08	.05-.06	.04-.05
Fine sandy loam	.13-.15	.12-.14	.10-.12	.09-.11	.08-.09	.06-.08	.06-.07	.04-.05	.04-.05
Sandy loam	.11-.13	.10-.12	.09-.10	.07-.09	.07-.08	.05-.07	.05-.06	.04-.05	.03-.04
Loamy very fine sand	.10-.12	.09-.11	.08-.10	.07-.08	.06-.07	.05-.06	.04-.05	.03-.04	.03-.04
Loamy fine sand	.09-.11	.08-.10	.07-.09	.06-.07	.05-.07	.04-.06	.04-.05	.03-.04	.03
Loamy sand	.06-.08	.05-.07	.05-.06	.04-.06	.04-.05	.03-.04	.03-.04	.02-.03	.02
Fine sand	.05-.07	.04-.06	.04-.06	.03-.05	.03-.04	.03-.04	.02-.03	.02-.03	.01-.02

<sup>1/</sup> Use this chart only when NASIS or more site specific information is not available. Compiled by NRCS, National Soil Survey Laboratory, Lincoln, Nebraska.

**Table 2-3** Available water capacity adjustment factors <sup>1/</sup>

Modifying factor (%)	" + " Increased AWC	" - " Decreased AWC
Rock content		Rocks decrease soil and pore space volume
Sodicity		Sodium salts disperse clays, decreases soil aggregation and destroys structure increasing soil density.
Salinity		Increased salt concentration makes it more difficult for the plant to take in water by osmosis. The tension required to extract water from the soil is increased.
Organic matter (0 to +10%)	In general, OM increases aggregation and improves soil structure, decreases soil density, and increases AWC. In sandy soils, OM provides fine particles, which effectively reduces average particle size.	
Soil structure (-10% to +10%)	Granular, blocky, columnar and Prismatic (low density)	Single grain (sand - large sized pores release large proportion of gravitational water).  Massive or platy (usually high density).
Compaction (-20% to 0)		Compaction increases soil density, reduces pore space and decreases permeability.
Restrictive layers (0 to +10%)	Restrictive layers in the subsoil can effectively increase AWC of upper layers after an irrigation or rain. Water, held up by the restrictive layer, has the potential to be all or partially used by the plants.	Restrictive layers can restrict root development and water movement lower in the soil profile.

*See footnote at end of table.*

**Table 2-3** Available water capacity adjustment factors <sup>1/</sup>—Continued

Modifying factor (%)	" + " Increased AWC	" - " Decreased AWC
Soil condition—the soil's physical condition related to tillage, micro-organism activity, erosion. (-10% to +10%)	Good soil condition results in decreased soil density, increased soil micro-organism activity, increased pore space.	Poor soil condition results in increased soil density, a more massive soil structure, decreased pore space, decreased soil micro-organism activity.
Depth within the soil come profile (-5% per foot)		In general, with increased depth, soils become more consolidated or dense, are affected by mineralization, have less structure and organic matter.
Vegetative cover (0 to +5%)	Root penetration improves soil structure and condition, and decreases soil density.	

<sup>1/</sup> Density can make AWC differences of -50% to +30% compared to average densities. Dense soils have low available water capacity because of the decreased pore space.

Different soils hold water and release it differently. When soil-water content is high, very little effort is required by plant roots to extract moisture. As each unit of moisture is extracted, the next unit requires more energy. This relationship is referred to as a soil moisture release characteristic. Figure 2-1 shows water release curves for typical sand, loam, and clay soils. The tension in the plant root must be greater than that in the soil at any water content to extract the soil water. Typically with most field crops, crop yield is not affected if adequate soil water is available to the plant at less than 5 atmospheres for medium to fine textured soils.

At soil-water tensions of more than about 5 atmospheres, plant yield or biomass is reduced in medium to fine textured soils.

Salts in the soil-water solution decrease the amount of water available for plant uptake. Maintaining a higher soil-water content with more frequent irrigations relieves the effect of salt on plant moisture stress. Table 2-4 displays AWC values adjusting for effect of salinity versus texture.  $EC_e$  is defined as the electrical conductivity of the soil-water extract corrected to 77 °F (25 °C). Units are expressed in millimhos per centimeter (mmho/cm) or deci Siemen per meter (dS/m). 1 mmho/cm = 1dS/m. See section 652.0202(i) for additional information.

Tension levels for field capacity and wilting point in table 2-4 are assumed.

AWC is the major soil factor in irrigation scheduling. Only a partial depletion of the AWC should be allowed. For most field crops and loamy soils, 50 percent is allowed to be depleted to limit undue plant moisture stress. For most vegetables, 30 percent depletion is desirable. As an example, data from figure 2-1 provides the following approximate potential (tension) levels for three general soil types:

Soil	Tension at 50% depletion	Tension at 30% depletion	Depletion at 5 bars tension
clay	4.5 bars	2.5 bars	55%
loam	2 bars	1.2 bars	70%
sand	< 1 bars	< 1 bars	84%

Allowed soil-water depletion is a management decision based on the type of crop grown, stage of crop growth, total AWC of the soil profile, rainfall patterns, and the availability of the pumped or delivered water. It is referred to as the Management Allowed Depletion, or MAD level. See Chapter 3, Crops, for MAD levels for optimum yield and quality of most crops. The conventional concepts of total soil volume AWC and MAD do not apply to microirrigation where root volumes and wetted volumes are restricted.

NEH, Section 15, Chapter 1, Soil-Plant-Water Relationships provides an excellent and thorough description of soil-water relationships; therefore, the information included here is quite limited.

**Figure 2-1** Typical water release curves for sand, loam, and clay

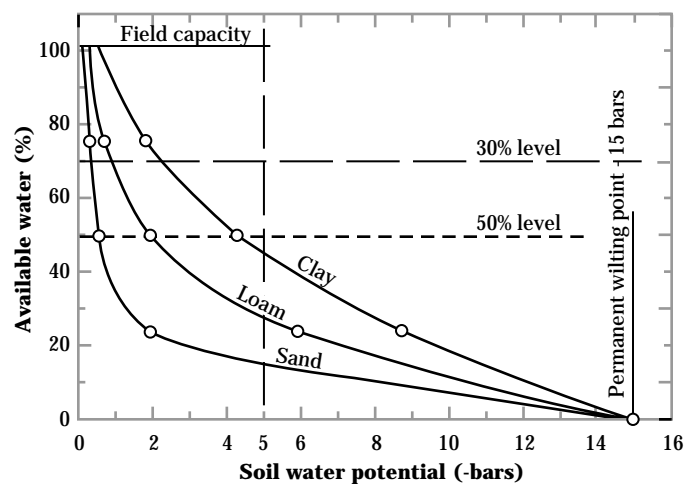

Texture	Tension level (atmospheres or bars)	
	@ field capacity	@ Perm. wilting point
Course	0.1	15.0
Medium & fine	0.33	15.0

**Table 2-4** Available water capacity adjustments because of salinity <sup>1/</sup>

Soil texture	Electrical conductivity (IC <sub>e</sub> x 10 <sup>3</sup> )							
	0	2	4	6	8	10	12	14
	----- Available water capacity (inch/inch) <sup>2/</sup> -----							
clay	.14-.16	.13-.15	.12-.14	.11-.13	.10-.12	.09-.11	.07-.08	.04-.05
silty clay	.15-.17	.14-.16	.13-.15	.12-.14	.11-.12	.09-.11	.07-.08	.05-.06
sandy clay	.15-.17	.14-.16	.13-.15	.12-.14	.11-.12	.09-.11	.07-.08	.05-.06
silty clay loam	.19-.21	.18-.20	.17-.18	.15-.17	.14-.15	.12-.13	.09-.10	.06-.07
clay loam	.19-.21	.18-.20	.17-.18	.15-.17	.14-.15	.12-.13	.09-.10	.06-.07
sandy clay loam	.14-.16	.13-.15	.12-.14	.11-.12	.09-.11	.08-.09	.06-.07	.03-.04
silt loam	.19-.21	.18-.20	.17-.18	.15-.17	.14-.15	.12-.13	.09-.10	.06-.07
loam	.16-.18	.15-.17	.14-.16	.13-.15	.12-.13	.10-.11	.08-.09	.05-.06
very fine sandy loam	.15-.17	.14-.16	.13-.15	.12-.14	.11-.12	.09-.11	.07-.08	.05-.06
fine sandy loam	.13-.15	.12-.14	.11-.13	.11-.12	.09-.11	.08-.09	.06-.07	.04-.05
sandy loam	.11-.13	.10-.12	.10-.11	.09-.11	.08-.09	.07-.08	.05-.06	.03-.04
loamy very fine sand	.10-.12	.10-.11	.09-.11	.08-.09	.07-.08	.06-.07	.04-.05	.02-.03
loamy fine sand	.09-.11	.09-.10	.08-.10	.07-.09	.06-.08	.06-.07	.04-.05	.03-.04
loamy sand	.06-.08	.06-.08	.05-.07	.05-.06	.04-.06	.04-.05	.03-.04	.02-.03
fine sand	.05-.07	.05-.07	.04-.06	.04-.06	.04-.05	.03-.04	.02-.03	.02

1/ Compiled by NRCS National Soil Survey Laboratory, Lincoln, Nebraska.

2/ 15 mmhos conductivity results in 75 to 95 percent reduction in available water capacity.

**(3) Soil texture**

Soil texture refers to the weight proportion of the soil separates (sand, silt, and clay) for the less than 2 mm fraction, as determined from a laboratory particle size distribution analysis. It defines the fineness or coarseness of a soil. Particle sizes larger than 2 mm are classed as rock or coarse fragments and are not used to define texture. Table 2-5 shows terms and symbols used in describing soil textures.

Fine textured soils generally hold more water than coarse textured soils. Medium textured soils actually have more available water for plant use than some clay soils. Water in clay soils can be held at a greater tension that reduces its availability to plants.

Figure 1-2, of NEH, Part 623, Chapter 1, Soil-Plant-Water Relationship, displays what is commonly referred to as the USDA textural triangle. It describes the proportions of sand, silt, and clay in the basic textural classes. Texture determines the amount of surface area on soil particles within the soil mass. Clay and humus both exist in colloidal state and have an extremely large surface area per unit weight. They carry surface electrical charges to which ions and water are attracted.

The USDA Soils Manual includes the following general definitions of soil textural classes in terms of field experience. These definitions are also specifically used in estimating soil-water content by the *feel and appearance method*. See Chapter 9, Irrigation Water Management and Chapter 15, Irrigation Water Management Plan.

**Sand**—Sand is loose and single-grained. The individual grains can be readily seen and felt. Squeezed in the hand when dry, sand falls apart when pressure is released. Squeezed when moist, it forms a cast, but crumbles when touched.

**Sandy loam**—A sandy loam is soil containing a high percentage of sand, but having enough silt and clay to make it somewhat coherent. The individual sand grains can be readily seen and felt. Squeezed when dry, a sandy loam forms a cast that falls apart readily. If squeezed when moist, a cast can be formed that bears careful handling without breaking.

**Table 2-5** General terms, symbols, and size of soil separates for basic soil texture classes (USDA, SCS 1993)

Texture	Soil	Symbol	
<b>Sandy soils:</b>			
Coarse	<b>Sands</b>		
	Coarse Sand	COS	
	Sand	S	
	Fine sand	FS	
	Very fine sand	VFS	
	<b>Loamy sands</b>		
	Loamy coarse sand	LCOS	
	Loamy sand	LS	
	Loamy fine sand	LFS	
	Loamy very fine sand	LVFS	
<b>Loamy soils:</b>			
Moderately coarse	Coarse sandy loam	COSL	
	Sandy loam	SL	
	Fine sandy loam	FSL	
Medium	Very fine sandy loam	VFSL	
	Loam	L	
	Silt loam	SIL	
	Silt	SI	
Moderately fine	Clay loam	CL	
	Sandy clay loam	SCL	
	Silty clay loam	SICL	
<b>Clayey soils:</b>			
Fine	Sandy clay	SC	
	Silty clay	SIC	
	Clay	C	
<b>Size of soil separates:</b>			
Texture	Size (mm)	Texture	Size (mm)
GR	> 2.0	FS	0.25 – 0.10
VCOS	2.01.0	VFS	0.10 – 0.05
COS	1.0 – 0.5	SI	0.05 – 0.002
MS	0.5 – 0.25	C	< 0.002

**Loam**—A loam is soil having a relatively even mixture of different grades of sand, silt, and clay. It is friable with a somewhat gritty feel, but is fairly smooth and slightly plastic. Squeezed when dry, it forms a cast that bears careful handling, and the cast formed by squeezing the moist soil can be handled freely without breaking.

**Silt loam**—A silt loam is soil having a moderate amount of fine sand with a small amount of clay. Over half of the particles are silt size particles. When dry, a silt loam appears cloddy, but the lumps can be readily broken. When pulverized, it feels soft and floury. When wet, the soil runs together readily and puddles. Either dry or moist, silt loam forms a cast that can be handled freely without breaking. When moist and squeezed between thumb and finger, it does not ribbon, but has a broken appearance.

**Clay loam**—A clay loam is moderately fine-textured soil that generally breaks into clods or lumps that are hard when dry. When the moist soil is pinched between the thumb and finger, it forms a thin ribbon that breaks readily, barely sustaining its own weight. The moist soil is plastic and forms a cast that bears much handling. When kneaded in the hand, clay loam does not crumble readily, but works into a heavy compact mass.

**Clay**—A clay is fine-textured soil that usually forms very hard lumps or clods when dry and is very sticky and plastic when wet. When moist soil is pinched between thumb and finger, it forms a long flexible ribbon. Some clays that are very high in colloids are friable and lack plasticity at all moisture levels.

**Organic**—Organic soils vary in organic matter content from 20 to 95 percent. They generally are classified on the degree of decomposition of the organic deposits. The terms muck, peat, and mucky peat are commonly used. Muck is well-decomposed organic material. Peat is raw, undecomposed, very fibrous organic material in which the original fibers constitute all the material.

#### (4) Soil structure

Soil structure is the arrangement and organization of soil particles into natural units of aggregation. These units are separated from one another by weakness planes that persist through cycles of wetting and drying and cycles of freezing and thawing. Structure influences air and water movement, root development, and nutrient supply.

Structure type refers to the particular kind of grouping that predominates in a soil horizon. Single-grained and massive soils are structureless. In single-grained soils, such as loose sand, water percolates rapidly. Water moves very slowly through most clay soils. A more favorable water relationship occurs in soils that have prismatic, blocky and granular structure. Platy structure in fine and medium soils impedes the downward movement of water. See figure 2-2. Structure can be improved with cultural practices, such as conservation tillage, improving internal drainage, liming or adding sulfur to soil, using grasses in crop rotation, incorporating crop residue, and adding organic material or soil amendments. Structure can be destroyed by heavy tillage equipment or excess operations.

Texture, root activity, percent clay, percent organic matter, microbial activity, and the freeze-thaw cycle all play a part in aggregate formation and stability. Some aggregates are quite stable upon wetting, and others disperse readily. Soil aggregation helps maintain stability when wet, resist dispersion caused by the impact from sprinkler droplets, maintain soil intake rate, and resist surface water and wind erosion. Irrigation water containing sodium can cause dispersing of soil aggregates. See discussion of SAR in Section 652.0202(i). Clay mineralogy has a major influence on soil aggregation and shrink-swell characteristics. See NEH, part 623, chapter 1, for additional discussion.

**Figure 2-2** Examples of soil structure

**Platy**—The units are flat and plate-like. They are generally oriented horizontal. (Soil Survey Manual, fig. 3-26, p. 159)



**Prismatic**—The individual units are bounded by flat to rounded vertical faces. Units are distinctly longer vertically, and the faces are typically casts or molds of adjoining units. Vertices are angular or subrounded; the tops of the prisms are somewhat indistinct and normally flat. (Soil Survey Manual, fig. 3-27, p. 159)

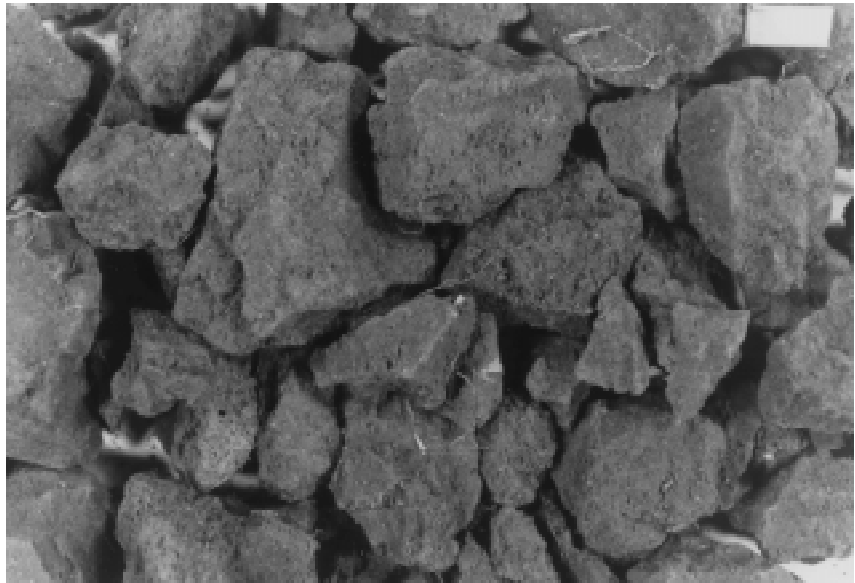

**Figure 2-2** Examples of soil structure—Continued

**Columnar**—The units are similar to prisms and are bounded by flat or slightly rounded vertical faces. The tops of columns, in contrast to those of prisms, are very distinct and normally rounded. (Soil Survey Manual, fig. 3-28, p. 160)



**Blocky**—The units are block like or polyhedral. They are bounded by flat or slightly rounded surfaces that are casts of the faces of surrounding peds. Typically, blocky structure units are nearly equi-dimensional, but grade to prisms and plates. The structure is further described as angular blocky (with sharp corners) and subangular blocky (with rounded corners). (Soil Survey Manual, fig. 3-29, p. 161)



**Figure 2-2** Examples of soil structure—Continued

**Granular**—The units are approximately spherical or polyhedral and are bounded by curves or irregular faces. (Soil Survey Manual, fig. 3-30, p. 161)

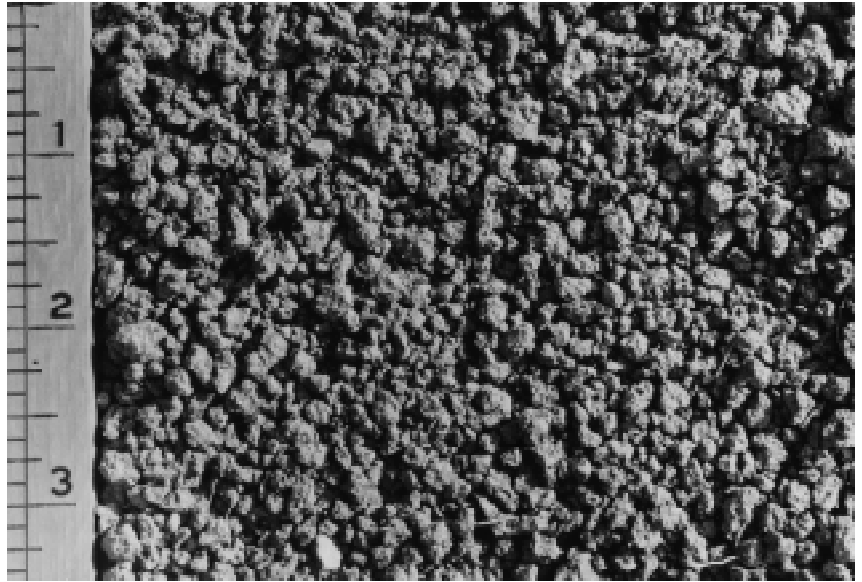

**(5) Soil bulk density**

Refers to the weight of a unit volume of dry soil, which includes the volume of solids and pore space. Units are expressed as the weight at oven-dry and volume at field capacity water content, expressed as grams per cubic centimeter (g/cc) or pounds per cubic foot (lb/ft<sup>3</sup>). Soil is composed of soil particles, organic matter, water, and air.

**(6) Soil pore space**

Bulk density is used to convert water measurements from a weight basis to a volume basis that can be used for irrigation related calculations. Many tools are available to measure bulk density in the field as well as in the laboratory. They are described in Chapter 9, Irrigation Water Management. Exhibit 2-2 displays the process to determine the total volume of water held in a soil.

Pore space allows the movement of water, air, and roots. Dense soils have low available water capacity because of decreased pore space. Density can make AWC differences of -50 percent to +30 percent compared to average densities. Sandy soils generally have bulk densities greater than clayey soils. Sandy soils

have less total pore space than silt and clay soils.

Gravitational water flows through sandy soils much faster because the pores are much larger. Clayey soils hold more water than sandy soils because clay soils have a larger volume of small, flat-shaped pore spaces that hold more capillary water. Clay soil particles are flattened or platelike in shape, thus, soil-water tension is also higher for a given volume of water. When the percent clay in a soil increases over about 40 percent, AWC is reduced even though total soil-water content may be greater. Permeability and drainability of soil are directly related to the volume and size and shape of pore space.

Uniform plant root development and water movement in soil occur when soil profile bulk density is uniform, a condition that seldom exists in the field. Generally, soil compaction occurs in all soils where tillage implements and wheel traffic are used. Compaction decreases pore space, decreasing root development, oxygen content, and water movement and availability. Other factors affecting soil bulk density include freeze/thaw process, plant root growth and decay, worm-holes, and organic matter.

**Exhibit 2-2** Process to determine total volume of water held in a soil

<p><b>Let:</b> <math>D_b</math> = bulk density  <math>D_p</math> = particle density (specific gravity)  <math>W_s</math> = weight of soil solids (oven dry)  <math>W_w</math> = weight of soil water  <math>V_s</math> = volume of solids  <math>V_p</math> = volume of pores (both air &amp; water)  <math>V_w</math> = volume of water  <math>V_s + V_p</math> = total soil volume</p> $D_b = \frac{W_s}{V_s + V_p} \quad D_p = \frac{W_s}{V_s} \quad D_b \times V_s = D_p (V_s + V_p)$ $\frac{V_s}{V_s + V_p} = \frac{D_b}{D_p} \quad \% \text{ Solids} = \frac{V_s}{V_s + V_p} \times 100 = \frac{D_b}{D_p} \times 100$ $\% \text{ pore space} = 100 - \left( \frac{D_b}{D_p} \times 100 \right) \quad \% \text{ water} = \frac{W_w}{W_s} \times 100$ $\% \text{ volume of water} = \frac{V_w}{V_s + V_p} \times 100 = \frac{W_w}{W_s} \times D_b \times 100$ $\text{Volume of water (in/ft)} = \frac{\% \text{ volume of water} \times 12 \text{ in/ft}}{100}$	<p><b>Schematic:</b></p>
---	--------------------------

### (c) Soil intake characteristics

Soil intake/water infiltration is the process of water entering the soil at the soil/air interface. NEH, Part 623, Chapter 1, Soil-Plant-Water Relationship provides detailed discussion of the water infiltration process.

Infiltration rates change during the time water is applied, typically becoming slower with elapsed time. They typically decrease as the irrigation season progresses because of cultivation and harvest equipment. This is especially true if operations are done at higher soil-water content levels. Preferential flow paths, such as cracks and wormholes, influence infiltration and permeability. Infiltration rates are also affected by water quality; for example, suspended sediment, temperature, sodicity, and SAR, affect water surface tension.

Soil intake characteristics affect design, operation, and management of surface irrigation systems.

#### (1) Surface irrigation systems

The water infiltration capability of a soil is referred to as soil intake characteristic. For surface irrigation systems, intake characteristic is expressed by the equation:

$$F = aT_o^b + c$$

where:

- F = Cumulative intake for an opportunity time period (inches)
- a = Intercept along the cumulative intake axis
- T<sub>o</sub> = Opportunity time (minutes)
- b = Slope of cumulative intake vs. time curve
- c = Constant (commonly 0.275)

(See NEH, Part 623, Chapter 4, Border Irrigation, and Chapter 5, Furrow Irrigation.)

Soil intake characteristics directly influence length of run, required inflow rate, and time of set that provide a uniform and efficient irrigation without excessive deep percolation and runoff. Table 2-6 displays estimated soil infiltration characteristics for border, furrow and fixed set or periodic move sprinkler irrigation systems based on surface soil texture.

For surface systems, water is considered ponded where it is 2 to 8 inches deep. Water infiltration for borders and basins is vertically downward. For furrows, infiltration is vertically downward, horizontal, and upward into furrow ridges. More field testing has been done for borders than for furrows; therefore, intake estimates for borders are more readily available. These intake characteristics can be converted for use with furrows, but the intake process differences must be accounted for in the conversion.

Figure 2-3 displays intake groupings used for designing border and basin and contour surface irrigation systems. Figure 2-4 displays intake groupings used for designing furrow irrigation systems. Furrow intake characteristics differ from border and basin intake characteristics because of the direction of water movement near the soil surface and the percent of soil surface covered by water.

**Table 2-6** Soil intake ranges by surface texture <sup>1/</sup>

Soil texture	Intake characteristics		
	Sprinkle	Furrow	Border & basin
C, SIC	.1 - .2	.1 - .5	.1 - .3
SC, SICL	.1 - .4	.2 - .8	.25 - .75
CL, SCL	.1 - .5	.2 - 1.0	.3 - 1.0
SIL, L	.5 - .7	.3 - 1.2	.5 - 1.5
VFSL, FSL	.3 - 1.0	.4 - 1.9	1.0 - 3.0
SL, LVFS	.3 - 1.25	.5 - 2.4	1.5 - 4.0
LFS, LS	.4 - 1.5	.6 - 3.0	2.0 - 4.0
FS, S	.5 +	1.0 +	3.0 +
CS	1.0 +	4.0 +	4.0 +

<sup>1/</sup> These are estimates based on soil texture. They should be used only where local data are not available.

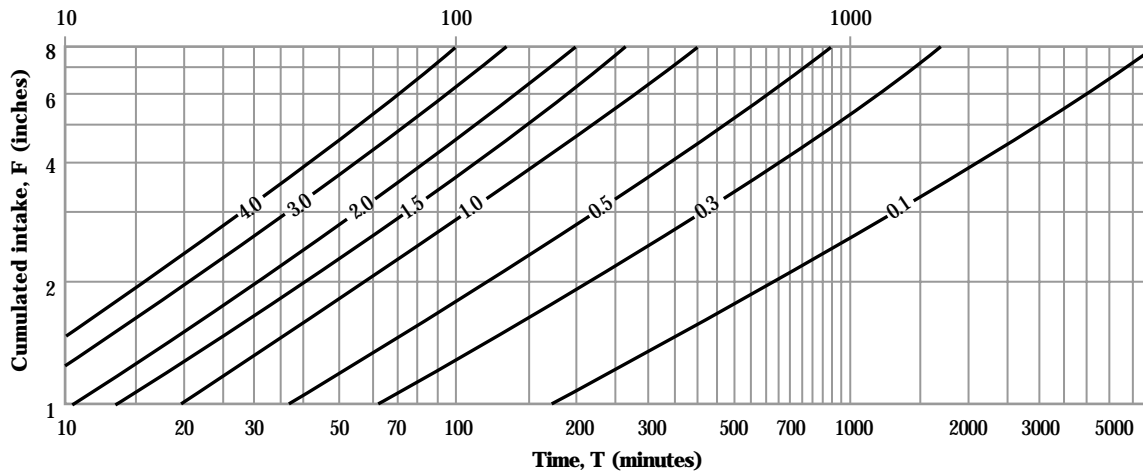
**Figure 2-3** Intake families for border and basin irrigation design

$$F = aT_o^b + c$$

F = cumulative intake for an opportunity time T period (inches)

a = intercept along the cumulative intake axis

$T_o$  = opportunity time (minutes)

b = slope of cumulative intake vs. time curve

c = constant (commonly 0.275)

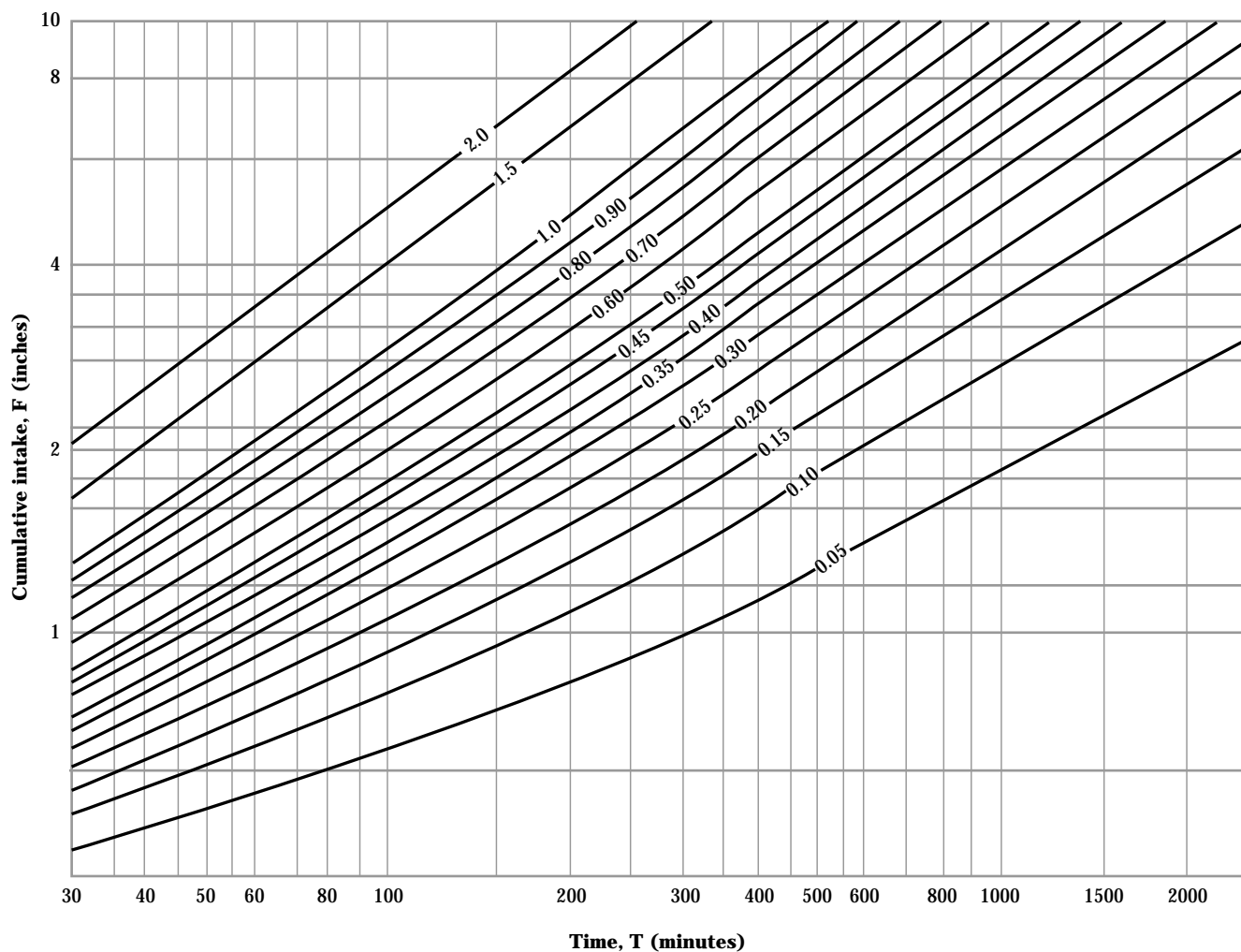
**Figure 2-4** Intake families for furrow irrigation design <sup>1/</sup>

$$F = aT_0^b + c$$

F = cumulative intake for an opportunity time T period (inches)

a = intercept along the cumulative intake axis

T<sub>0</sub> = opportunity time (minutes)

b = slope of cumulative intake-vs. time curve

c = constant <sup>2/</sup> (commonly 0.275)

<sup>1/</sup> Source: NEH, Section 15, Chapter 5, Furrow Irrigation.

<sup>2/</sup> Constant can be adjusted based on local information.

## (2) Sprinkler irrigation systems

For sprinkle irrigation, infiltration is referred to as either an intake rate or maximum application rate, expressed as inches per hour (in/hr). Application rates and timing vary according to type of sprinkler or spray head. With impact heads, water on the ground surface is at a single point only with each head rotation. With spray heads, water is on the ground surface continuously, but at very shallow depth. Soil surface storage is important where water is applied in short time periods; i.e., the outer end of low pressure center pivot laterals.

Caution should be used when comparing average sprinkler application rates with published soil infiltration values. Some of the problems include:

- Low angle nozzles apply proportionally more water in the area nearest the nozzle.
- Peak instantaneous application rates under continuously self-moving sprinkler laterals can be very high. However, when expressed as an average hourly rate over the total irrigated area, these rates may appear quite low. For example: A 1-inch irrigation application being made at the outer end of a quarter mile long Low Pressure In Canopy center pivot lateral can apply water at instantaneous rates exceeding 50 inches per hour for 2 to 10 minutes, but the average hourly rate is considerably less. In medium and fine textured soils, the amount infiltrated during the application period can be very low.

Adequate soil surface storage is required to limit translocation of water within the field and perhaps field runoff during the infiltration process. Sprinkler systems should be designed with application rates that do not exceed the soil intake rate unless soil surface storage or other considerations are made.

Water droplet impact on a bare soil surface from sprinkler systems can cause dispersion of some soils. The bigger the droplets, the more the potential dispersion and microcompaction of soil particles. Bigger droplets are generally a result of inadequate operating pressure or long distances from the nozzle to the point of impact. This action forms a dense and less permeable thin surface layer that can reduce the infiltration

rate significantly. This condition is most likely to occur on soils that are

- sodic,
- poorly graded,
- bare,
- contain low organic matter,
- have little or no surface residue, and
- have limited vegetation canopy.

Table 2-7 displays the estimated maximum net application amounts and rates for center pivot systems. The table displays the sprinkler intake group and the amount of soil surface storage needed to apply an allowable irrigation amount. All systems are considered to be 1,320 feet in length. The following systems are compared in the table:

- High pressure impact heads with a peak rate of 1.0 in/hr.
- Medium pressure impact heads with a peak rate of 1.5 in/hr.
- Low pressure impact heads with a peak rate of 2.5 in/hr.
- Low pressure spray, two direction system with peak rate of 3.5 in/hr.
- Low pressure spray, one direction system with peak rate of 6.0 in/hr.

Values for various slopes for the maximum allowable net application amount without additional storage created by special practices, are:

Field slope (%)	Approximate soil surface storage (in)
0 - 1	0.5
1 - 3	0.3
3 - 5	0.1
> 5	0.0

The infiltration process is different when using sprinkler and border (or furrow) irrigation. With border irrigation, a small head or depth of water (pressure) is placed on the soil surface. With sprinkler and microirrigation, the soil surface remains mostly unsaturated. The association with sprinkle application rate and border intake family is through surface texture.

**Table 2-7** Maximum net application amounts with zero potential runoff for center pivot systems

Border intake group	Typical application rate <sup>1/</sup> (in/hr)	Pressure & sprinkler type	Maximum allowable net application amount			
			----- surface storage -----			
			0.0 <sup>2/</sup> (in)	0.1 (in)	0.3 (in)	0.5 (in)
A (0.1)	1.0	High-impact	0.2	0.4	0.8	1.1
	1.5	Medium-impact	0.2	0.3	0.7	0.9
	2.5	Low-impact	0.1	0.3	0.6	0.8
	3.5	Low-spray	0.1	0.3	0.5	0.7
	6.0	<b>2 direction</b> Low-spray	0.1	0.3	0.5	0.7
B (0.3)	1.0	<b>1 direction</b> High-impact	0.8	1.2	1.3	2.2
	1.5	Medium-impact	0.5	0.7	1.2	1.7
	2.5	Low-impact	0.2	0.5	0.8	1.2
	3.5	Low-spray	0.2	0.3	0.7	1.0
	6.0	<b>2 direction</b> Low-spray	0.1	0.3	0.5	0.8
C (0.5)	1.0	<b>1 direction</b> High-impact	2.0	2.5	3.3	4.0
	1.5	Medium-impact	1.0	1.4	1.9	2.5
	2.5	Low-impact	0.4	0.7	1.2	1.6
	3.5	Low-spray	0.3	0.5	0.9	1.3
	6.0	<b>2 direction</b> Low-spray	0.1	0.3	0.7	0.9
D (1.0)	1.0	<b>1 direction</b> High-impact	4.0	4.0	4.0	4.0
	1.5	Medium-impact	4.0	4.0	4.0	4.0
	2.5	Low-impact	1.4	1.9	2.6	3.2
	3.5	Low-spray	0.6	1.1	1.7	2.2
	6.0	<b>2 direction</b> Low-spray	0.3	0.6	0.9	1.3
E (1.5 +)	No general restrictions within practical design criteria. Local experience may dictate specific restrictions.					

1/ If higher rates are used, the application amounts should be appropriately reduced. The rates shown are not necessarily the maximum allowable application rate.

2/ Estimated soil surface storage (without additional storage created by special practices, such as pitting, damming, diking, and contour furrows).

Table 2-8 displays estimated maximum sprinkler application rates for fixed set or periodic move sprinkler systems. It is recognized that border intake families or groups do not relate to the infiltration process using sprinkle irrigation. However, many field technicians are familiar with soils identified by these groups, so they are used for familiarity.

Table 2-9 gives information that can be used to refine infiltration values. Field measurements and local experience should be used to support or change published values.

**Table 2-8** Maximum sprinkler application rate—periodic move and fixed set sprinkler (for alfalfa-grass, grass, or clean tilled with residue > 4,000 lb/ac)

Sprinkler intake group	Design slope (%)	----- Net sprinkler application (in) -----								
		≤1.0	1.5	2.0	2.5	3.0	3.5	4.0	4.5	5.0
A	0.4 or less	0.70	0.25	0.15	0.15					
	0.75 to 1.25	0.45	0.20	0.15	0.10					
	2.0	0.35	0.20	0.15	0.10					
	3.0	0.30	0.20	0.15	0.10					
	5.0 to 8.0	0.25	0.15	0.15	0.10					
B	0.40 or less	1.70	0.70	0.50	0.40	0.35	0.30	0.30	0.30	0.25
	0.75 to 1.25	1.20	0.60	0.45	0.40	0.35	0.30	0.30	0.30	0.25
	2.0	1.00	0.60	0.45	0.40	0.35	0.30	0.30	0.25	0.25
	3.0	0.80	0.55	0.45	0.40	0.35	0.30	0.30	0.25	0.25
	5.0 to 8.0	0.70	0.50	0.40	0.35	0.30	0.30	0.30	0.25	0.25
C	0.40 or less	2.75	1.15	0.85	0.75	0.65	0.60	0.55	0.50	0.50
	0.75 to 1.25	2.05	1.05	0.85	0.70	0.65	0.60	0.55	0.50	0.50
	2.0	1.65	1.00	0.80	0.70	0.60	0.55	0.55	0.50	0.50
	3.0	1.40	0.95	0.75	0.65	0.60	0.55	0.55	0.50	0.50
	5.0 to 8.0	1.15	0.85	0.75	0.65	0.60	0.55	0.50	0.50	0.45
D	0.40 or less	5.40	2.40	1.85	1.60	1.45	1.35	1.25	1.20	1.15
	0.75 to 1.25	4.00	2.25	1.80	1.55	1.40	1.30	1.25	1.20	1.15
	2.0	3.30	2.10	1.75	1.55	1.40	1.30	1.25	1.20	1.15
	3.0	2.90	2.00	1.70	1.50	1.40	1.30	1.20	1.15	1.10
	5.0 to 8.0	2.40	1.85	1.60	1.40	1.35	1.25	1.20	1.15	1.10
E	All slopes	No restrictions within practical design criteria								

Cover adjustment for clean tilled crops

- with 3,000 to 4,000 lb/ac, use 90% of above
- with 2,000 to 3,000 lb/ac, use 80% of above
- with 1,000 to 2,000 lb/ac, use 70% of above
- with less than 1,000 lb/ac, use 60% of above

Includes the following reduction of intake for surface storage:

0.75 to 1.25	= 0.4 in
2.0	= 0.3 in
3.0	= 0.2 in
5.0 to 8.0	= 0.0 in

Note: Sprinkler intake groups are based on major soil texture groups, as follows:

- A—Border intake family - 0.1
- B—Border intake family - 0.3
- C—Border intake family - 0.5
- D—Border intake family - 1.0
- E—Border intake family - 1.5 +

**Table 2-9** Soil intake family adjustment factors

<b>Texture</b>	Fine textured soils generally have slower intake rates than coarse textured soils.
<b>Structure</b>	The arrangement of soil particles into aggregates affects intake as follows: <ul style="list-style-type: none"> <li>• Single grain or granular structure = most rapid intake</li> <li>• Blocky or prismatic structure = moderate intake</li> <li>• Massive or platy structure = slowest intake</li> </ul>
<b>Bulk density</b>	Dense soils have grains tightly packed together. The effect of density on intake can be -50% to +30% from the typical.

**Modifying factors:**

Modifying factor (%)	" + " Increased intake rate	" - " Decreased intake rate
Initial water content -20% to +20%	Low initial water content.	High initial water content.
Organic content -10% to +10%	High organic content improves soil structure and promotes good condition.	Low organic content provides for a more massive soil structure.
Compaction -50% to 0		Compaction results in higher density with less pore space to hold water.
Hardpan -50% to 0		Hardpan (a very dense layer).
Gravel or coarse sand layer, near surface -30% to 0		The soil layer above an abrupt boundary of coarse material must be saturated before water will move into the coarse material below.
Salinity and sodicity -20% to +10%	Calcium salts can flocculate the surface soil.	Sodium salts can disperse and puddle the soil.
Surface crusting -20% to 0		Surface sealing.
Sediments in the irrigation water -20% to 0 <sup>1/</sup>		Colloidal clays and fine sediment can accumulate on the soil surface.
Cracking -40% to +40%	Cracking increases initial intake. Intake rate can be high until cracks close because of added moisture causing soil particles to swell.	On highly expansive soils, intake rate can be very slow after cracks close because the soil particles swell.

*See footnote at end of table.*

**Table 2-9** Soil intake family adjustment factors—Continued

Modifying factor (%)	" + " Increased intake rate	" - " Decreased intake rate
Vegetative cover -20% to +20%	Root penetration promotes improved soil structure and lower soil density. Worm activity increases providing macropores for water to follow.	Bare soil tends to puddle under sprinkler systems using large droplet sizes increasing soil density at the soil surface.
Soil condition (physical condition of the soil related to micro-organism activity and erosion) -10% to +10%	Good soil condition reduces soil density.	Poor soil condition increases soil density, restricts root development, and restricts worm activity.
Ripping, subsoiling 0 to +20%	Ripping when soil is dry can break up hardpans, shatter dense soils, and in general improve the soil condition below plow depth. The effect is temporary unless the cause of increased density is eliminated.	
Soil erosion -20% to 0		Erosion exposes subsurface layers that are lower in organic content, have poor structure, can have increased salinity or sodicity, and generally have higher density.

1/ This estimate may need local adjustment.

Center pivot systems, because of their configuration, have higher application rates in the outer fourth of the circle. The longer the pivot lateral, the higher the application rate in the outer portion. To maintain their usefulness on medium or fine textured and sloping soils, surface storage is essential to prevent translocation of applied water. Surface storage can be provided by:

- Soil surface roughness or cloddiness developed from tillage equipment
- In-furrow chiseling or ripping
- Crop residue on the soil surface
- Basin tillage
- Permanent vegetation
- Any combination of these

Surface storage must be available throughout the irrigation season. Tables 2-10a through 2-10g display the surface storage needed for various sprinkler intake groups for continuous/self-moving sprinkler systems. These tables are based on surface soil texture.

Figures 2-5a and 2-5b provide a process to estimate surface storage for reservoir tillage (constructing in-row dikes or dams and small reservoirs) of varying spacing, widths, and heights. Figure 2-5a provides dike nomenclature.

Figure 2-5b provides the maximum capacity of applied depth of irrigation water as a function of dike height and bottom width of reservoir. This figure was developed for furrow slope of 1 percent only.

**Table 2-10a** Amount of surface storage needed for no runoff—Silty clay (sprinkler intake rate group = 0.1 - 0.2 in/hr)

Application sprinkler rate (in/hr)	----- Total amount of application ----- ----- (inches) -----					
	0.5	1	1.5	2	2.5	3
1	0.0	0.4	0.7	1.1	1.6	2.0
2	0.1	0.5	0.9	1.4	1.8	2.2
3	0.1	0.5	1.0	1.4	1.9	2.4
4	0.1	0.6	1.0	1.5	2.0	2.4
5	0.1	0.6	1.1	1.5	2.0	2.5
6	0.2	0.6	1.1	1.5	2.0	2.5
10	0.2	0.6	1.1	1.6	2.1	2.6
25	0.2	0.7	1.2	1.7	2.1	2.6
50	0.2	0.7	1.2	1.7	2.2	2.7
100	0.2	0.7	1.2	1.7	2.2	2.7
200	0.2	0.7	1.2	1.7	2.2	2.7

**Table 2-10b** Amount of surface storage needed for no runoff—Silty clay loam (sprinkler intake rate group = 0.1 - 0.4 in/hr)

Application sprinkler rate (in/hr)	----- Total amount of application ----- ----- (inches) -----					
	0.5	1	1.5	2	2.5	3
1	0.0	0.0	0.3	0.6	0.9	1.2
2	0.0	0.3	0.7	1.0	1.4	1.8
3	0.0	0.4	0.8	1.2	1.6	2.0
4	0.1	0.5	0.9	1.3	1.7	2.2
5	0.1	0.5	0.9	1.4	1.8	2.2
6	0.1	0.5	1.0	1.4	1.9	2.3
10	0.1	0.6	1.0	1.5	2.0	2.4
25	0.2	0.7	1.1	1.6	2.1	2.6
50	0.2	0.7	1.2	1.7	2.1	2.6
100	0.2	0.7	1.2	1.7	2.2	2.7
200	0.2	0.7	1.2	1.7	2.2	2.7

**Table 2-10c** Amount of surface storage needed for no runoff—Silt loam (sprinkler intake rate group = 0.1 - 0.6 in/hr)

Application sprinkler rate (in/hr)	----- Total amount of application ----- ----- (inches) -----					
	0.5	1	1.5	2	2.5	3
1	0.0	0.0	0.0	0.0	0.2	0.4
2	0.0	0.1	0.4	0.7	1.0	1.4
3	0.0	0.3	0.6	1.0	1.3	1.7
4	0.0	0.1	0.7	1.1	1.5	1.9
5	0.0	0.1	0.8	1.2	1.6	2.0
6	0.1	0.5	0.9	1.3	1.7	2.1
10	0.1	0.5	1.0	1.4	1.9	2.3
25	0.2	0.6	1.1	1.6	2.0	2.5
50	0.2	0.7	1.2	1.6	2.1	2.6
100	0.2	0.7	1.2	1.7	2.2	2.7
200	0.2	0.7	1.2	1.7	2.2	2.7

**Table 2-10e** Amount of surface storage needed for no runoff—Fine sandy loam (sprinkler intake rate group = 0.3 - 1.0 in/hr)

Application sprinkler rate (in/hr)	----- Total amount of application ----- ----- (inches) -----					
	0.5	1	1.5	2	2.5	3
1	0.0	0.0	0.0	0.0	0.0	0.0
2	0.0	0.0	0.0	0.0	0.1	0.3
3	0.0	0.0	0.2	0.5	0.7	1.0
4	0.0	0.1	0.4	0.7	1.0	1.3
5	0.0	0.2	0.5	0.9	1.2	1.6
6	0.0	0.3	0.6	1.0	1.3	1.7
10	0.1	0.4	0.8	1.2	1.6	2.0
25	0.1	0.6	1.0	1.5	1.9	2.4
50	0.2	0.6	1.1	1.6	2.1	2.5
100	0.2	0.7	1.2	1.6	2.1	2.6
200	0.2	0.7	1.2	1.7	2.2	2.7

**Table 2-10d** Amount of surface storage needed for no runoff—Loam (sprinkler intake rate group = 0.2 - 0.7 in/hr)

Application sprinkler rate (in/hr)	----- Total amount of application ----- ----- (inches) -----					
	0.5	1	1.5	2	2.5	3
1	0.0	0.0	0.0	0.0	0.0	0.0
2	0.0	0.0	0.0	0.0	0.0	0.0
3	0.0	0.0	0.0	0.0	0.2	0.4
4	0.0	0.0	0.1	0.4	0.6	0.8
5	0.0	0.1	0.3	0.6	0.9	1.2
6	0.0	0.2	0.4	0.7	1.0	1.4
10	0.0	0.3	0.7	1.1	1.4	1.8
25	0.1	0.5	1.0	1.4	1.8	2.3
50	0.2	0.6	1.1	1.5	2.0	2.5
100	0.2	0.7	1.1	1.6	2.1	2.6
200	0.2	0.7	1.2	1.7	2.2	2.6

**Table 2-10f** Amount of surface storage needed for no runoff—Loamy fine sand (sprinkler intake rate group = 0.4 - 1.5 in/hr)

Application sprinkler rate (in/hr)	----- Total amount of application ----- ----- (inches) -----					
	0.5	1	1.5	2	2.5	3
1	0.0	0.0	0.0	0.0	0.0	0.0
2	0.0	0.0	0.0	0.0	0.0	0.0
3	0.0	0.0	0.0	0.0	0.0	0.0
4	0.0	0.0	0.0	0.0	0.2	0.4
5	0.0	0.0	0.1	0.3	0.5	0.8
6	0.0	0.0	0.3	0.5	0.8	1.0
10	0.0	0.3	0.6	0.9	1.3	1.6
25	0.1	0.5	0.9	1.3	1.8	2.2
50	0.2	0.6	1.1	1.5	2.0	2.4
100	0.2	0.7	1.1	1.6	2.1	2.6
200	0.2	0.7	1.2	1.7	2.1	2.6

**Table 2-10g** Amount of surface storage needed for no runoff—Fine sand (sprinkler intake rate group = 0.5 in/hr +)

Application sprinkler rate (in/hr)	----- Total amount of application ----- (inches)-----					
	0.5	1	1.5	2	2.5	3
1	0.0	0.0	0.0	0.0	0.0	0.0
2	0.0	0.0	0.0	0.0	0.0	0.0
3	0.0	0.0	0.0	0.0	0.0	0.0
4	0.0	0.0	0.0	0.0	0.0	0.0
5	0.0	0.0	0.0	0.0	0.0	0.0
6	0.0	0.0	0.0	0.1	0.2	0.4
10	0.0	0.1	0.4	0.6	0.9	1.2
25	0.1	1.4	0.8	1.2	1.6	2.0
50	0.1	0.6	1.0	1.4	1.9	2.3
100	0.2	0.6	1.1	1.6	2.0	2.5
200	0.2	0.7	1.2	1.6	2.1	2.6

**Figure 2-5a** Nomenclature—dike spacing and height; furrow width and ridge height and spacing

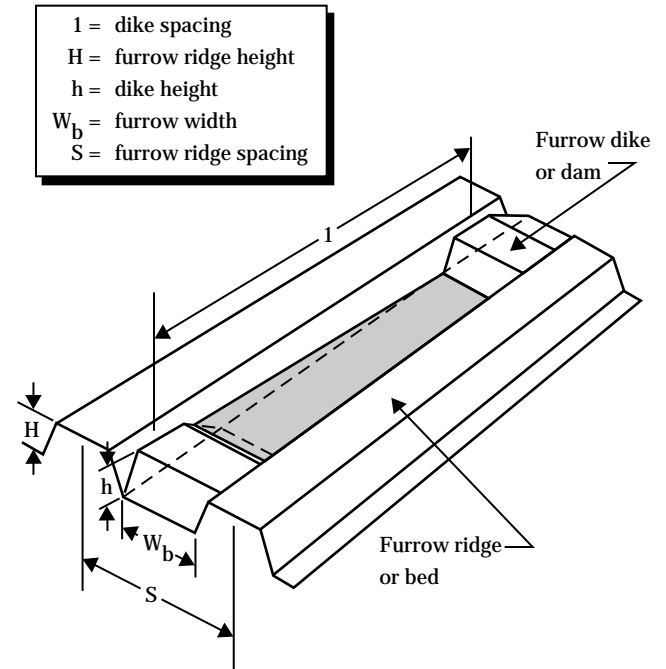

**Figure 2-5b** Dike spacing, height, and surface storage capacity (maximum capacity of applied depth of irrigation water as a function of dike height and bottom width of reservoir for field slope of 1%; for slopes other than 1%, divide storage volume by actual percent slope)

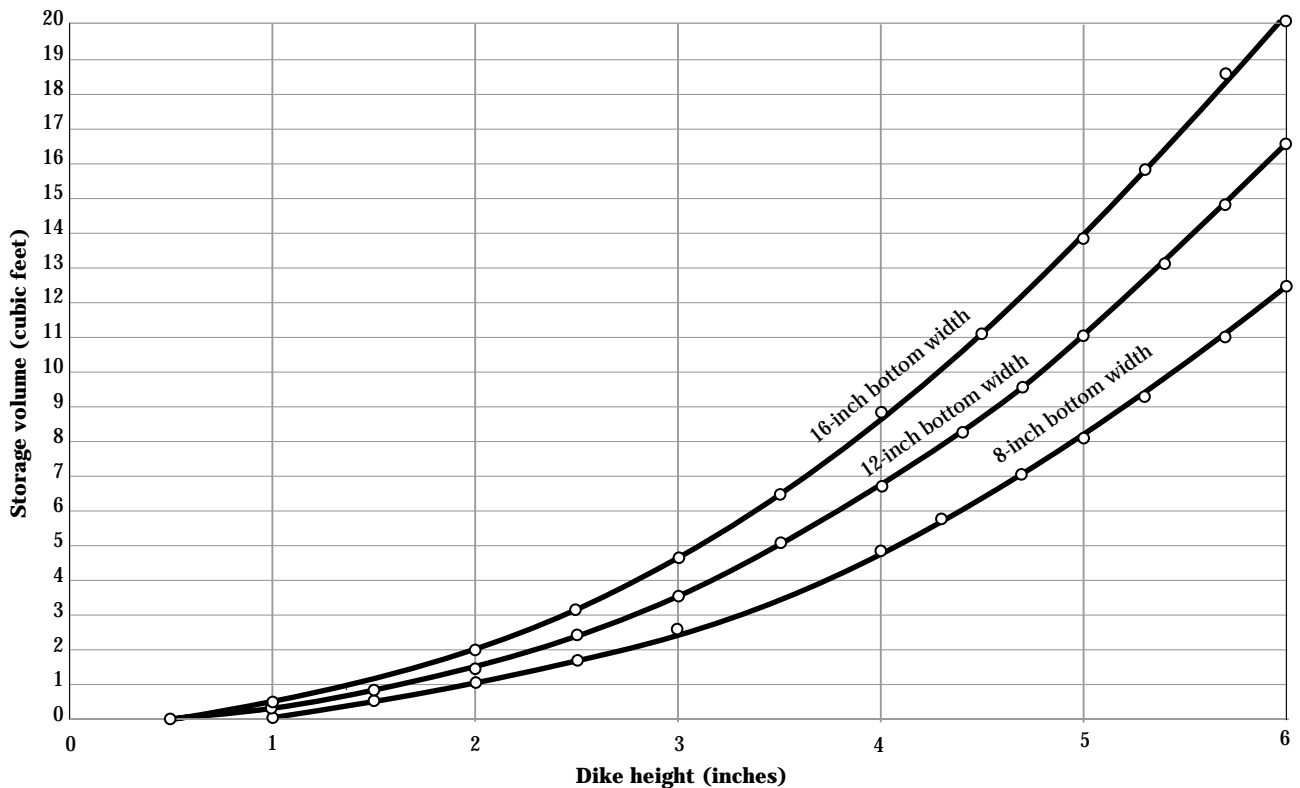

Table 2–11 displays estimates of effective surface storage for various tillage operations for basin storage on level or nearly level slopes. These estimates are based on averages from many field measurements. Tables 2–12 and 2–13 can be used to estimate effective surface storage with cloddy bare ground and residue only on level or nearly level slopes.

**Table 2–11** Estimated effective basin surface storage

Tillage operation	Effective storage depth (in)
Basin tillage	1.2
Reservoir (dammer-diker)	0.75
Subsoiler	0.16
Field cultivator	0.12

**Table 2–12** Surface storage available for rough and cloddy bare ground

Slope (%)	Surface storage (in)
0.5	0.5
2.0	0.3
4.0	0.1
4.5	0

**Table 2–13** Surface storage available with residue

Residue (%)	Surface storage (in)
0	0.0
10	.01
20	.03
30	.07
40	.12
50	.18
60	.24
70	.35

## (d) Organic matter

Soil organic matter is the organic fraction of the soil. It includes plant and animal residue at various stages of decomposition and cells and tissues of soil organisms. Organic matter directly influences soil structure, soil condition, soil bulk density, water infiltration, plant growth and root development, permeability, available water capacity, biological activity, oxygen availability, nutrient availability, and farmability, as well as many other factors that make the soil a healthy natural resource for plant growth. Organic matter has a high cation adsorption capacity, and its decomposition releases nitrogen, phosphorous, and sulfur. Site specific organic matter values should always be used for planning and managing irrigation systems. Published values often are from sites that were managed quite differently.

## (e) Soil depth

Depth is the dimension from the soil surface to bedrock, hardpan, water table; to a specified soil depth; or to a root growth restrictive layer. The deeper the soil and plant roots, the more soil-water storage is available for plant use. Crop rooting depth and the resulting total AWC control the length of time plants can go between irrigations or effective rainfall events before reaching moisture stress. Equipment compaction layers or natural occurring impervious layers restrict the downward movement of water and root penetration. Providing artificial drainage of poorly drained soils increases soil depth for potential root development. Adequate soil drainage must be present for sustained growth of most plants.

An abrupt change in soil texture with depth can restrict downward water movement. For example, a coarse sand underlying a medium or fine textured soil requires saturation at the interface before substantial water will move into the coarser soil below. When a coarse textured soil abruptly changes to a medium or fine textured soil with depth, a temporary perched water table develops above the slower permeable soil. Stratified soils or shallow soils over hardpans or bedrock can also hold excess gravitational water at the interface. The excess water can move upward because of the increased soil particle surface tension (suction) as the soil water in the upper profile is used by plants. Thus, an otherwise shallow soil with low total AWC can have characteristics of a deeper soil.

### (f) Slope

Slope (field) gradient is the inclination of the soil surface from the horizontal, expressed as a percentage. For example, a 1.5 percent slope is a 1.5-foot rise or fall in 100 feet horizontal distance. In planning irrigation systems, slope is important in determining the type of irrigation system best suited to the site. It is also important in determining optimum and maximum application rates (or streamflow rates) for applying water.

Erosion potential from excessive surface irrigation flows increases as the slope and slope length increase. Potential runoff from sprinkler systems also increases as the slope increases, thus raising the opportunity for erosion to occur.

### (g) Water tables

Water tables can be a barrier for root development because of restricted oxygen availability. Through planned water table control and management, shallow ground water can supply all or part of the seasonal crop water needs. The water must be high quality, salt free, and held at or near a constant elevation. The water table level should be controlled to provide water according to crop needs. Figure 2-6 displays approximate water table contribution, based on soil texture and depth to water table. Some stratified soils respond poorly to water table control because of the restrictions to water movement. The NRCS computer model DRAINMOD can be used to analyze water tables and subsurface water movement. Documentation for the program includes definitions of factors.

### (h) Soil erodibility

The erodibility of a soil should be considered in the planning stage of any irrigation system. The rate and method at which water is applied should be controlled so that it will not cause excessive runoff and erosion.

Factors influencing soil erosion, such as stream size for surface systems, surface storage because of residue, microbasins, and vegetative cover, are not related to soil properties. Table 2-14 shows soil erodibility

hazard for surface irrigation. It is based on soil structure, permeability, percent organic matter, percent silt and very fine sand, and field slope. Three classes indicate degree of erosion hazard on irrigated cropland for planning surface irrigation. For erosion factor K, see section II of the Field Office Technical Guide.

**Figure 2-6** Water table contribution to irrigation requirement, as a function of soil type (texture) and water table depth

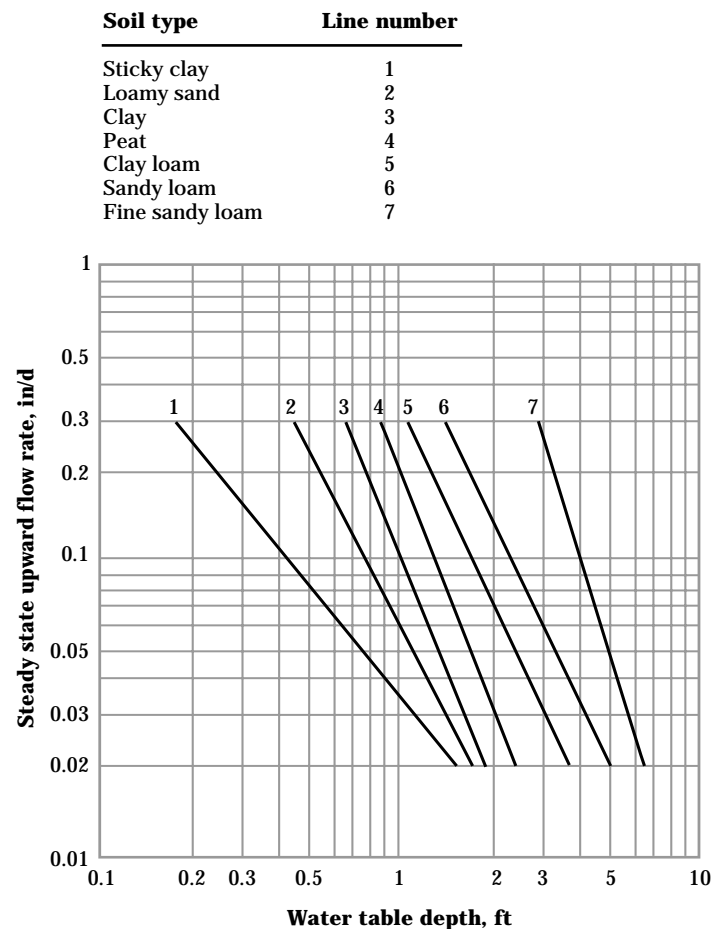

**Table 2-14** Soil erodibility hazard (S K values) for surface irrigation

Slope (%)	USLE "K" values											
	.10	.15	.17	.20	.24	.28	.32	.37	.43	.49	.55	.64
0.1	.01	.02	.02	.02	.02	.03	.03	.04	.04	.05	.06	.06
0.2	.02	.03	.03	.04	.05	.06	.06	.07	.09	.10	.11	.13
<b>Slight</b>												
0.3	.03	.05	.05	.06	.07	.08	.10	.11	.13	.15	.17	.19
0.4	.04	.06	.07	.08	.10	.11	.13	.15	.17	.20	.22	.26
0.5	.05	.08	.09	.10	.12	.14	.16	.19	.22	.25	.28	.32
1.0	.10	.15	.17	.20	.24	.28	.32	.37	.43	.49	.55	.64
1.5	.15	.23	.26	.30	.36	.42	.48	.56	.65	.74	.83	.96
<b>Moderate</b>												
2.0	.20	.30	.34	.40	.48	.56	.64	.74	.86	.98	1.10	1.28
3.0	.30	.45	.51	.60	.72	.84	.96	1.12	1.29	1.47	1.65	1.92
4.0	.40	.60	.68	.80	.96	1.12	1.28	1.48	1.72	1.96		
5.0	.50	.75	.85	1.00	1.20	1.40	1.60					
6.0	.60	.90	1.02	1.20	1.44	1.68						
7.0	.70	1.05	1.19	1.40	1.68							
<b>Severe</b>												
8.0	.80	1.20	1.36	1.60								
9.0	.90	1.35	1.53									
10.0	1.0	1.50										

Hazard class      S K value

Slight              < 0.2  
 Moderate          0.2 - 1.0  
 Severe             > 1.0

Where:

S = Slope in direction of irrigation

K = USLE Soil Erodibility

### (i) Chemical properties

Soil is formed primarily from the decomposition of rocks. Exposure of the rock surface to water, oxygen, organic matter, and carbon dioxide brings about chemical alterations on the rock material. Oxidation, reduction, hydration, hydrolysis, and carbonation contribute to rock disintegration and creation of new chemical compounds and solutions. The chemical and mineralogical composition of the soil vary with respect to depth or horizon. Weathering intensity decreases with depth from the surface. The longer the weathering has proceeded, the thicker the weathered layer and the greater the difference from the original material. In mineral soils, organic matter content generally decreases with depth.

The colloidal fraction (diameter less than 0.001 mm) of the soil plays an important part in the chemistry of the soil. Microbiological activity is greatest near the surface where oxygen, organic matter content, and temperature are the highest.

**Cation Exchange Capacity (CEC)** is the total amount of cations held in a soil in such a way that they can be removed by exchanging with another cation in the natural soil solution, expressed in milliequivalents per 100 grams of oven-dry soil (meq/100 gm). The cation exchange capacity is a measure of the ability of a soil to retain cations, some of which are plant nutrients. It is affected primarily by the kind and amount of clay and organic matter. Soils that have low CEC hold fewer cations and may require more frequent applications of fertilizers than soils with high CEC. See NASIS MUR data base or SCS-SOI-5 for CEC estimates for specific soil series.

### (j) Saline and sodic soil effects

Salt affected soils are generally classified as follows, using electrical conductivity of the soil-water extract,  $EC_e$ , as the basis:

Salinity	$EC_e$
Very Slight	0 – 4 dS/m
Slight	4 – 8 dS/m
Moderate	8 – 16 dS/m
Strong	> 16 dS/m

$EC_e$  is the electrical conductivity of soil-water extract corrected to 77 °F (25 °C), usually expressed in units of mmho per centimeter or deci-Siemens per meter.

$$1 \text{ mmho/cm} = 1 \text{ dS/m}$$

As water is evaporated from the soil surface or used by plants, salts and sodic ions within the soil-water solution are left behind either on the ground surface or within the soil profile. Accumulated saline salts can be reduced by leaching with excess water through the soil profile. This may need to be done regularly to maintain a proper salt balance for desirable plant growth. Figure 2-7 displays the effect of soil salinity on AWC on a clay loam soil.

A detailed description of soil and water salinity and sodicity is given in the American Society of Civil Engineers Report No. 71, Agricultural Salinity Assessment and Management (ASCE 1990), and in the National Engineering Handbook, Part 623, Chapter 2, Irrigation Water Requirements (USDA 1993).

Sodium Adsorption Ratio (SAR), is the standard measure of the sodicity of a soil or quality of the irrigation water. It replaces the previously used exchangeable sodium percentage (ESP).

**Figure 2-7** Example soil-water retention curves for clay loam soil at varying levels of soil salinity— $EC_e$

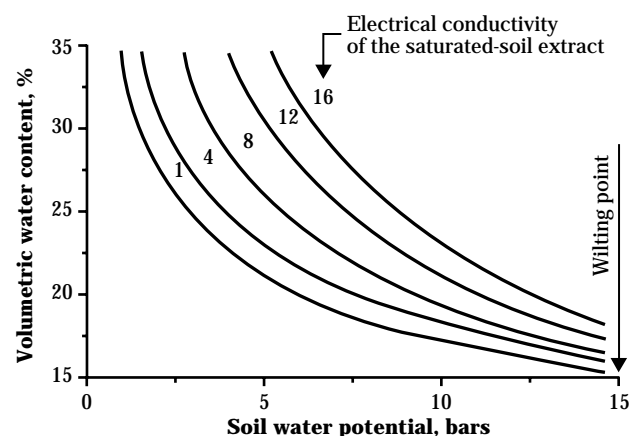

SAR is calculated from the concentration of sodium, calcium, and magnesium ions in the soil-water extract or irrigation water. See Chapter 3, Crops, and Chapter 13, Quality of Water Supply, for discussion of plant effects and quality of irrigation water. Sodium salts decrease the ability of the soil to infiltrate water because of soil structure dispersion or deflocculation. Figure 2-8 displays losses in permeability because of SAR and electrical conductivity of irrigation water.

(k) Soil reaction/acidity

Soil reaction is the degree of acidity of a soil, expressed as a pH value. Soil reaction is significant in crop production and in soil management because of the effect on solubility and availability of nutrients. A change in the degree of reaction may increase the solubility of other nutrients. This affects the amount of nutrients in the soil solution available for plant use, which significantly affects plant growth and crop yield. Figure 2-9 graphically displays the effect of pH on nutrient availability in soils.

**Figure 2-8** Threshold values of sodium adsorption ratio of topsoil and electrical conductivity of infiltrating water associated with the likelihood of substantial losses in permeability

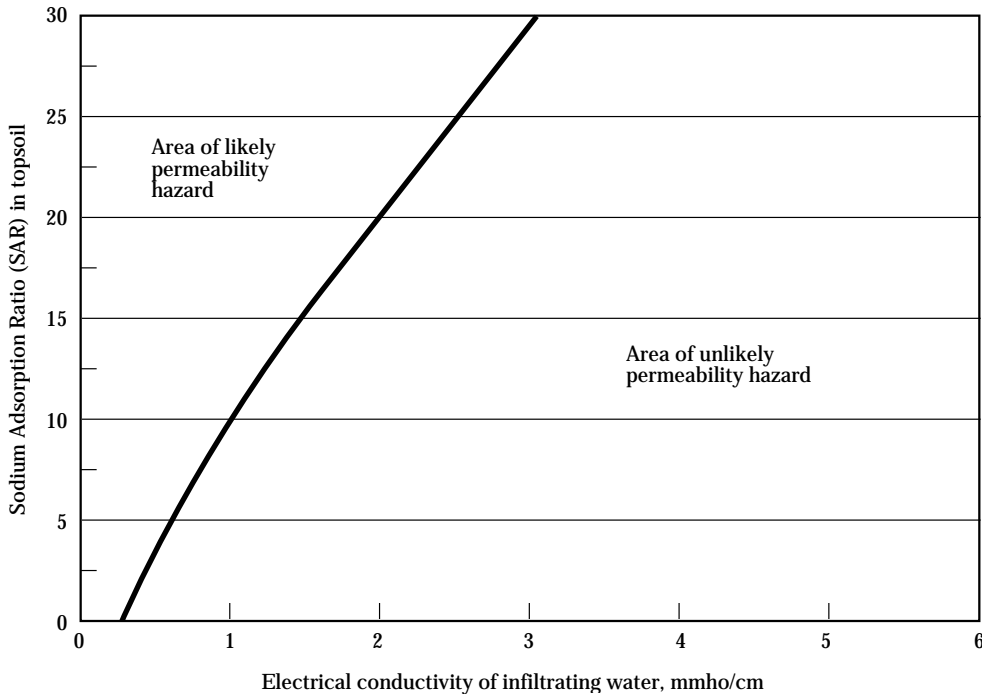

**Figure 2-9** Effect of pH on nutrient availability in soils (the wider the bar, the more available is the nutrient)

**Nutrient availability in soils: The wider the bar, the more available is the nutrient.**

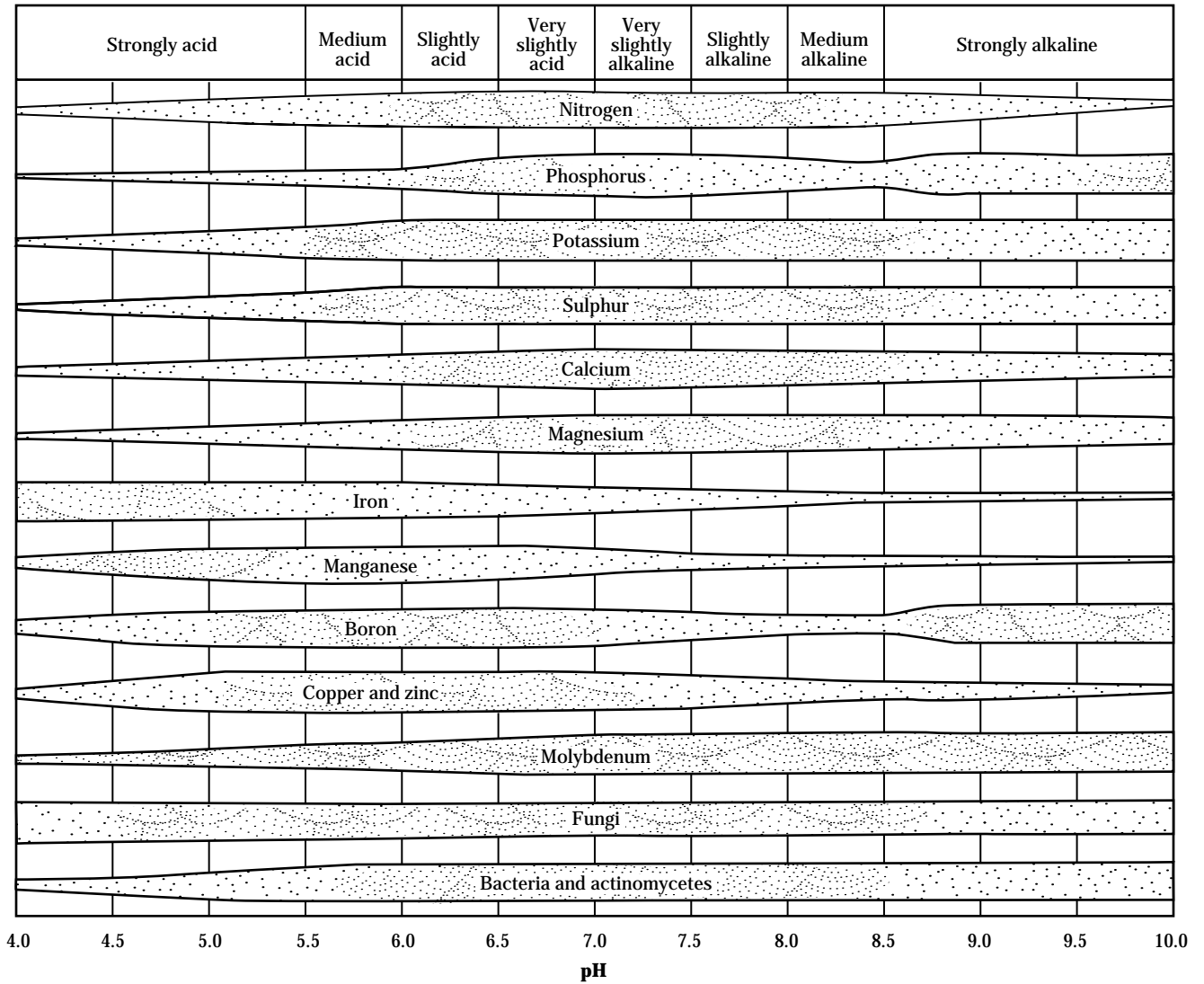

## 652.0203 Explanation of tables and data bases

State Soil Survey Database (SSSD) is a regional data base included in state soil survey data. It provides the soil data base for the Field Office Computer System (FOCS). SSSD has two major data sets: Map Unit Interpretations Record (MUIR) and Soils Interpretations Record (SIR) by soil series. From these, the NRCS soil interpretation record SCS-SOI-5 is developed and summaries of interpretations made.

National Soils Information System (NASIS) is the next generation of SSSD. When activated, NASIS will contain county specific values instead of ranges. In addition, it will provide metadata (data about data). For example: Was county specific available water capacity for those soil series and texture measured, calculated, or estimated.

## 652.0204 State supplement

### (a) Soil surveys

About (number) different soil series are irrigated in (state). These series are described in published or interim soil survey reports that cover approximately \_\_\_\_\_ percent of the potentially irrigable and existing irrigated area in the state. Soil series and interpretations are also available in Section II of the Field Office Technical Guide.

### (b) Soil properties

Table 2-15 displays soil properties and design values for irrigation, by soil series, for all the irrigated or potentially irrigated soils in (state). Values displayed are interpreted data taken from Section II of the Field Office Technical Guide, or represent actual field or laboratory tests. Soils specifically having field or laboratory test data are also indicated.

**Table 2-15** Soil properties and design values for irrigation <sup>1/</sup>

Soil series name	Depth (in)	Texture(s)	Depth to water table (ft)	AWC (in/in)	Depth (ft)	--- Cumulative AWC ---			---- Intake <sup>2/</sup> ----		Max sprink appl. rate (in/hr)
						Low (in)	Med. (in)	High (in)	Furrow I <sub>f</sub>	Border I <sub>f</sub>	
Fairdale	0 - 8	SIL, L	3 - 5	.18 - .22	1	2.1	2.3	2.6	.2 - 1.0	.1 - 1.0	.25 - .4
	8 - 30	SIL, L		.16 - .20	2	4.0	4.5	5.0			
	30 - 45	SICL, L	.15 - .19	3	5.9	6.6	7.3				
	45 - 60	S, GR - LS, GR	.03 - .04	4	7.3	8.2	9.1				
			5	7.7	8.2	9.1					

1/ Having specific field or laboratory test data.

2/ Range of estimated intake is provided. Use a mid value for trial designs.